

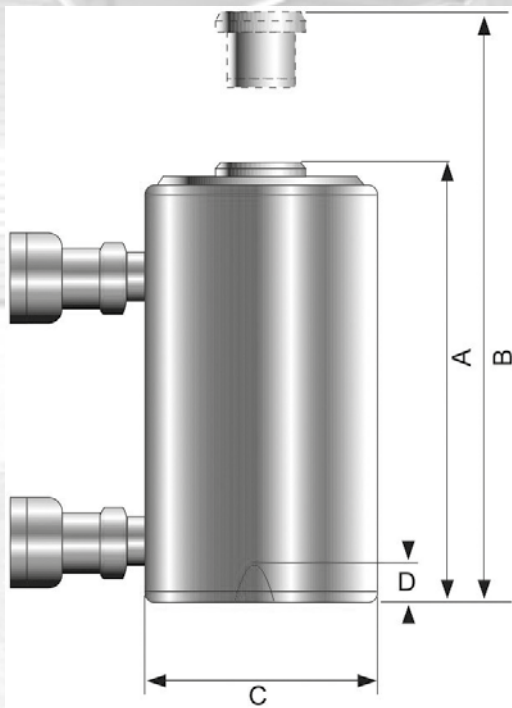

HYDRAULIK-ZYLINDER DOPPELTWIRKEND STANDARD



Artikel	TD-1012
A:	457 mm
B:	762 mm
C:	73 mm
Gewicht, kg:	14
Nennlast:	4 t (Zug) 10 t (Druck)
Ölvolumen:	159 ccm (Zug) 439 ccm (Druck)
Hub:	305 mm

